

Photon Mono M7 Pro

[▶ User Manual](#)

Dear customer,

Thank you for choosing Anycubic products.

Maybe you are familiar with 3D printing technology or have purchased Anycubic printers before. However, we still highly recommend you read this manual carefully, as the installation techniques and precautions can help you avoid any unnecessary damage or frustration.

Please visit <https://support.anycubic.com> to contact us if you have any questions. You can also learn more information from the website, such as software, videos, models.



Anycubic support center

Copyrighted by "Shenzhen Anycubic Technology Co., Ltd ", all rights reserved.

Team Anycubic

Safety Instructions

Always follow the safety instructions during assembly and usage, to avoid unnecessary damage to the 3D printer or individual injury.



Please contact our Customer Service if you have any issues after receiving the products.



In case of emergency, please immediately cut off the power of the 3D printer and contact our technical support.



UV light is harmful to the eyes; please avoid direct contact. When operating, wear protective equipment such as anti-UV goggles and gloves.



Anycubic 3D printer includes components that can cause injury.



When the Temperature control resin vat heats up for a long time, its surface temperature becomes high. Avoid touching the resin vat without protection after heating.



Be cautious when using the scraper, and make sure to orient the sharp parts of machine and tool away from people.



Keep the Anycubic 3D printer and its accessories out of the reach of children.



Vapors or fumes may be irritating at operating temperatures.

Always use the Anycubic 3D printer in an open and well ventilated area.



Do not expose Anycubic 3D printer to any water or rain environment.



Use Anycubic 3D printer in an environment with a temperature of 5°C-40°C and a humidity of 20%-80%. For optimal performance, do not exceed this range. Also, avoid direct sunlight exposure.



Do not disassemble Anycubic 3D printer, please contact technical support if you have any questions.



Contents

1. Product Overview	5
2. In the Box	7
3. Technical Specification	8
4. Recommended Print Parameters	9
5. Menu Directory	10
6. Preparations	14
7. File Upload	17
8. Print Test	21
9. Resin Test	27
10. Machine Maintenance	30
11. FAQ	35

Product Overview

All pictures are for reference only. Please comply with the actual products.

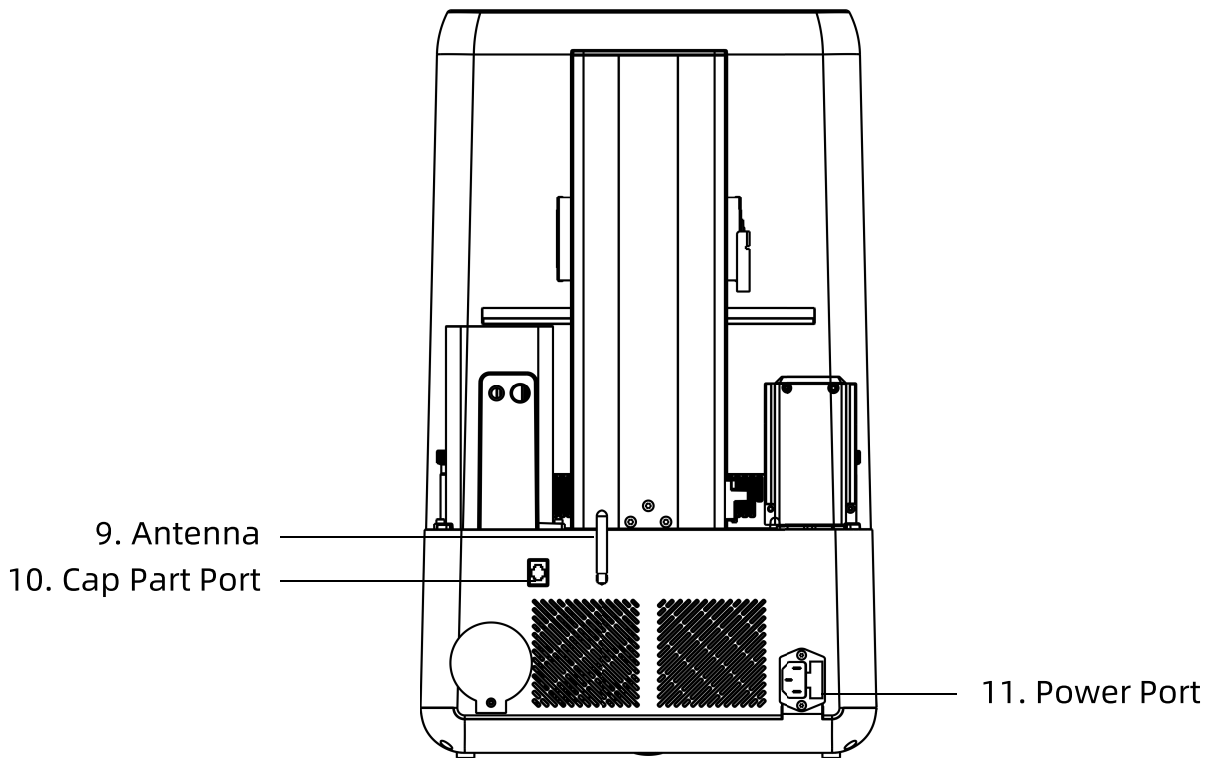
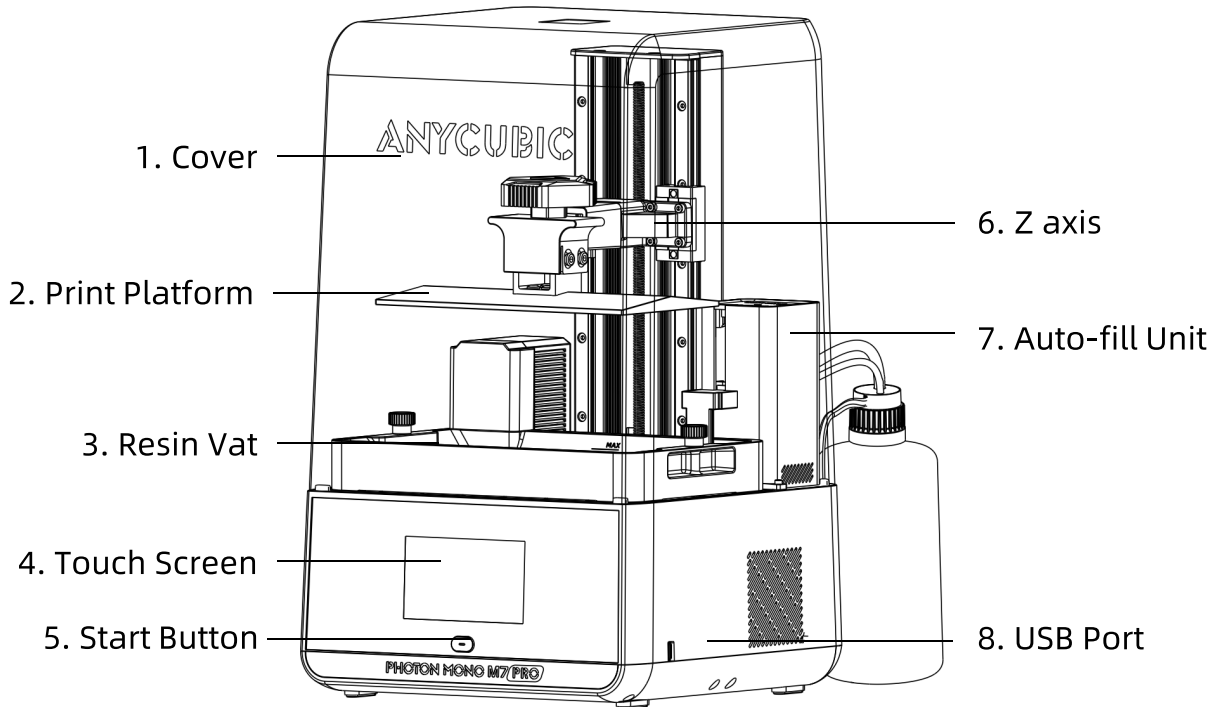

Auto-fill Unit

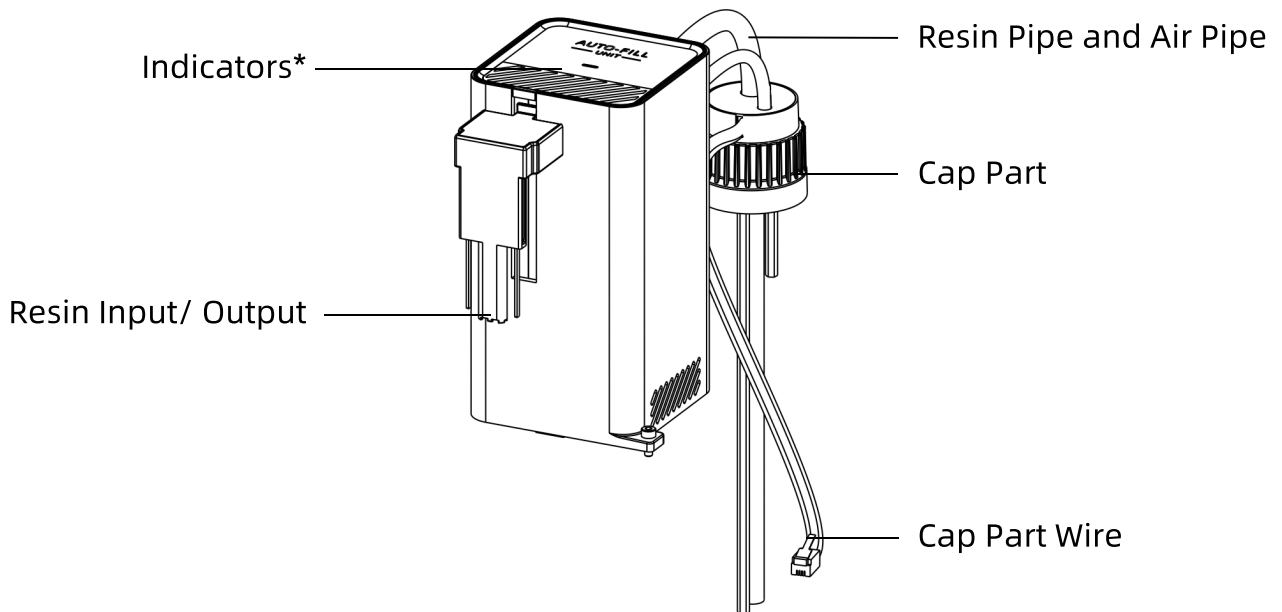

*Indicators: Green light indicates the connection of the main module.
Red light indicates that the resin in the bottle is insufficient.

In the Box

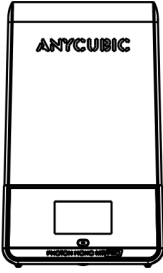

Photon Mono
M7 Pro

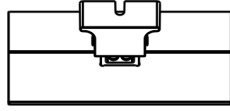

Print platform * 1

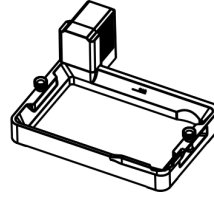

Resin vat * 1



Antenna



Hex key set

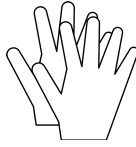

Protective equipment

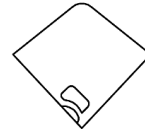

Funnel

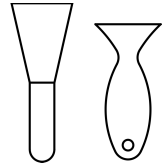

Scraper * 2



Screen protector kit



Leveling paper

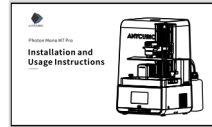

Manual * 1



USB drive * 1

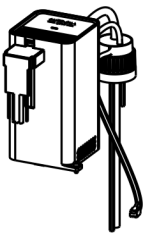

Auto-fill unit



Power cord

Operating System

System	Photon Mono M7 Pro
Software	Anycubic Photon Workshop (also compatible with other software)
Connectivity	USB Drive, WLAN

Specifications

LCD screen	10.1 inch 14K
Light source	COB light
XY Resolution	13312 * 5120
Z axis Accuracy	0.01 mm
Suggested Layer Thickness	0.01 ~ 0.15 mm

Physical Dimensions

Dimension	310 mm(L) *315 mm(W) *520 mm(H)
Build volume	223.64 mm(L) *126.48 mm(W) *230 mm(H)
Weight	12.8 kg

WLAN

Frequency Range	2.4 G (2.400~2.4835 GHz)
Work Mode	AP, STA, AP+STA mode

Recommended Print Parameters

Parameters Group	① Default Resin_Normal	② Default Resin_Fast	③ High Speed Resin
Layer Thickness	0.05 mm	0.1 mm	0.1 mm
Normal Exposure Time	1.8 s	2.2 s	1.4 s
Off Time	0.5 s		
Bottom Exposure Time	25 s	25 s	15 s
Bottom Layers	5	3	3
Z Lift Distance	8 mm	4 mm	4 mm
Z Lift Speed	6 mm/s	15 mm/s	15 mm/s
Z Retract Speed	6 mm/s	15 mm/s	15 mm/s
Anti-alias	1		
Notice	<p>1.If the print object needs high accuracy, please use group ① and modify the anti-alias level as 16 and the image blur as 3.</p> <p>2. The group ②③ apply to the model whose hollowed thickness is no more than 2mm.</p> <p>3. The group ②③ can significantly increase the print speed by cases test. To ensure the print success and print speed, do not modify the parameters casually.</p> <p>4. The group ②③ must work with the ACF release film this printer provided to avoid print failure. The film can be used to print 45000 layers.</p> <p>5. The group ③ only apply to Anycubic high speed resin.</p> <p>6. Refer to 17-18 pages for the instructions of parameter groups.</p>		

--The data above root in Anycubic lab, only for reference.

Menu Directory

Note: The current interface is for reference only. Please refer to the latest firmware for accurate information.

Home menu

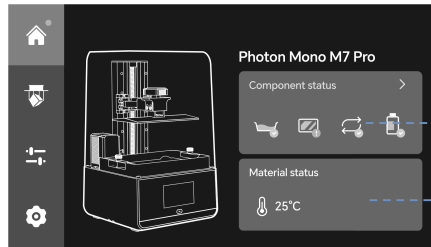

1. Temperature control
2. Statistic of print layers
3. Statistic of circulation time
4. Resin bottle connection

Resin temperature

Print

Print:

Switch to local file/ USB drive
file/cloud model library

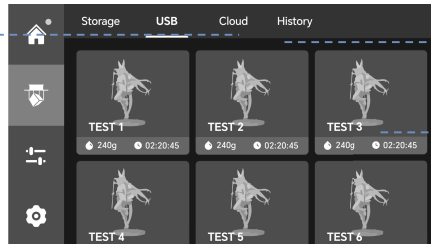

History

Click to enter into file details;
long press to edit the files.

File Details:

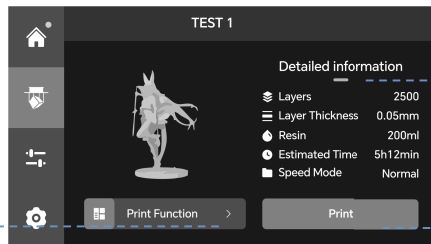

Print file information

Print function setting

Start the printing

History:

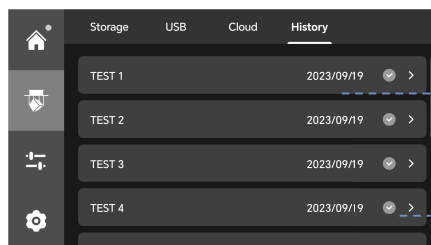

Print history,
Long press to edit

Click to check more details

Menu Directory

Tools

Z-axis:



The screenshot shows the 'Z-axis' menu with a top bar containing 'Z-axis', 'Exposure', 'Clear up', and 'Other'. Below the bar are four buttons: '0.1mm', '1mm', '10mm', and '50mm'. A central circular joystick has an upward arrow and a downward arrow. To the right are two buttons: 'Z-axis zero point' (with a house icon) and 'Leveling test' (with a leveling icon). A vertical toolbar on the left contains icons for home, stop, move up/down, and settings.

Move the Z axis upwards

Stop moving the Z axis

Move the Z axis downwards

Move Z by 0.1mm /1mm/10mm/50mm

Return to Zero

Move to check the effect of manual leveling (see page 30-31)

Exposure:

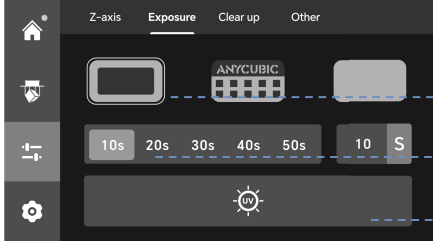

The screenshot shows the 'Exposure' menu with a top bar containing 'Z-axis', 'Exposure', 'Clear up', and 'Other'. Below the bar is a large image selection area with a grid of images, including one labeled 'ANYCUBIC'. Below the images are five buttons: '10s', '20s', '30s', '40s', and '50s', followed by a '10 S' button. At the bottom is a large button with a sun icon and a power symbol.

Choose an image to expose

Set the exposure time

Start exposure

Clear up:

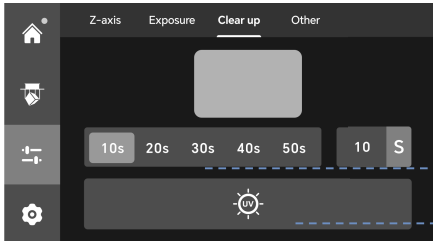

The screenshot shows the 'Clear up' menu with a top bar containing 'Z-axis', 'Exposure', 'Clear up', and 'Other'. Below the bar is a large image selection area. Below the images are five buttons: '10s', '20s', '30s', '40s', and '50s', followed by a '10 S' button. At the bottom is a large button with a sun icon and a power symbol.

Set the exposure time

Start exposure

Other:

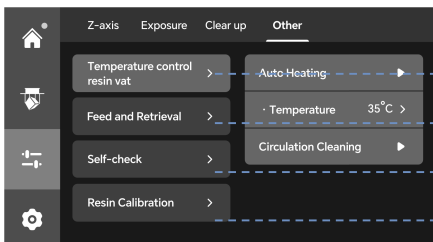

The screenshot shows the 'Other' menu with a top bar containing 'Z-axis', 'Exposure', 'Clear up', and 'Other'. Below the bar are four menu items, each with a right-pointing arrow: 'Temperature control resin vat', 'Feed and Retrieval', 'Self-check', and 'Resin Calibration'. To the right of these items are three buttons: 'Auto-Heating', 'Temperature 35°C', and 'Circulation Cleaning'.

Temperature control resin vat

Feed and retrieval

Self-check

Resin calibration

Tools

Other- Temperature control resin vat:

Set heating temperature

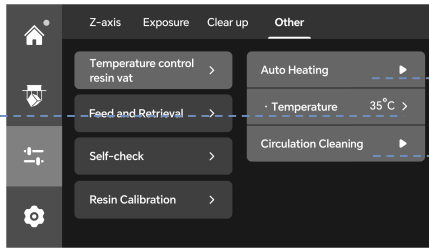

Start heating

Circulation cleaning steps

Other- Feed and Retrieval:

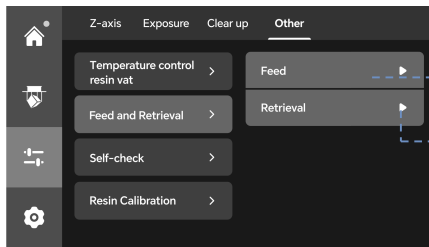

Start loading

Start unloading

Other- Self-check:

Check whether
WLAN module is on

Statistics of circulation time

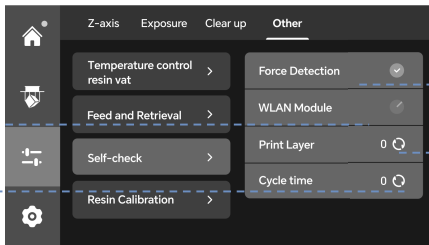

Start force detection

Statistics of print layers

Other- Resin Calibration:

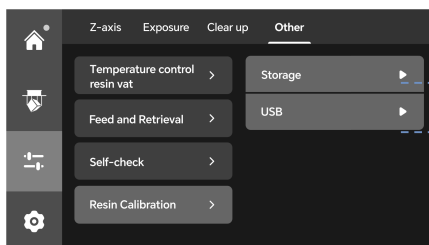

Local file list

USB drive list

Menu Directory

Settings

App:

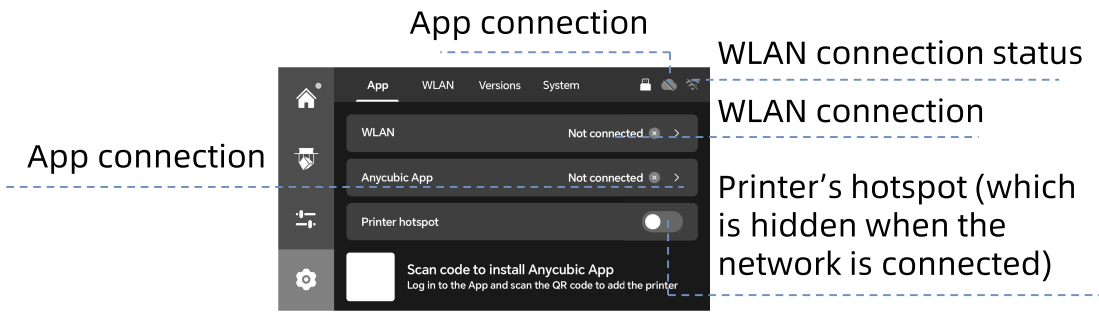

WLAN:

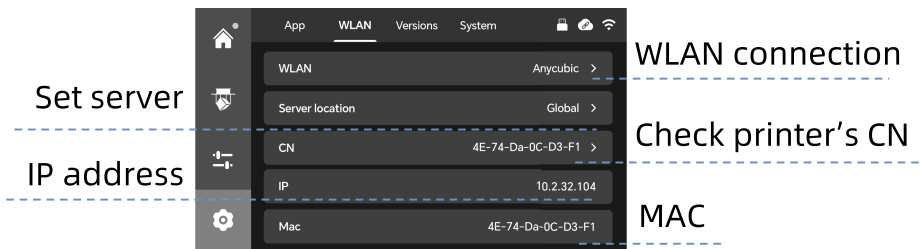

Version:

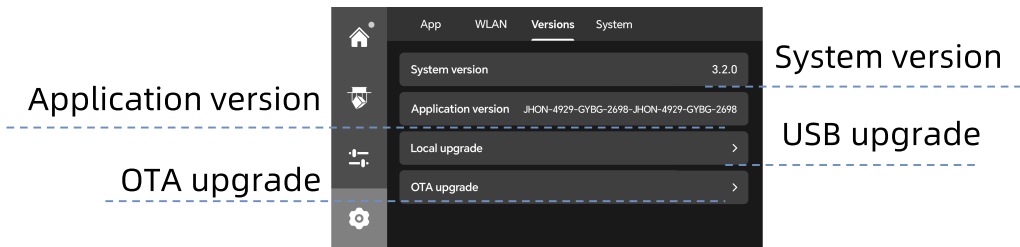

System:

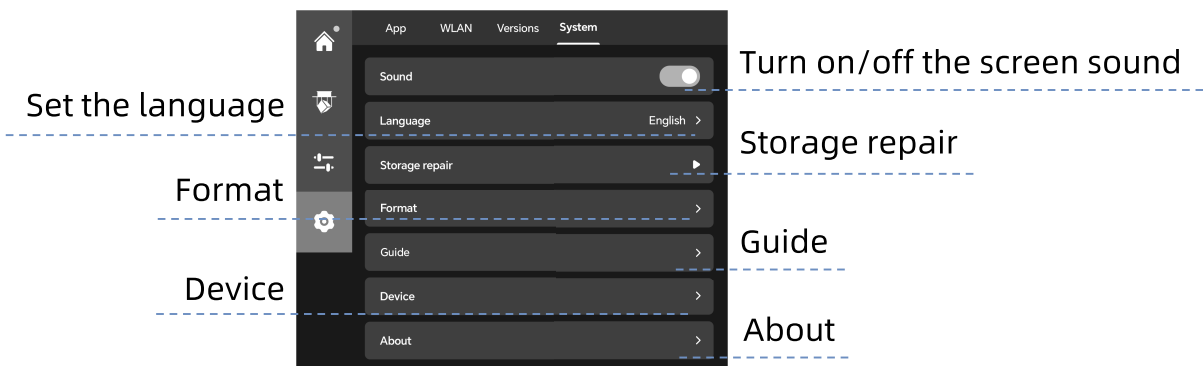

Preparations

Please place the 3D printer on a stable, level workbench and operate it in an open, well ventilated area away from sunlight. Refrain from using the printer in areas with ultraviolet light sources (such as fluorescent lamps or UV disinfection lamps) to prevent poor printing results. For the first use, please follow the instruction to finish the preparations.

1. Unbox, and take out the machine and its accessories.

2. Install the screen protector.

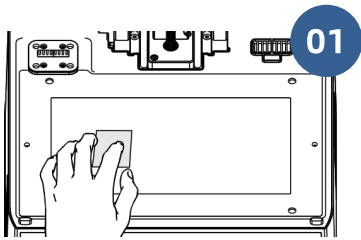

Peel off the protective film
Clean the LCD screen

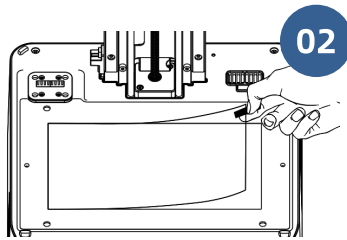

Peel off the film ①, then
align the LCD screen to
stick the screen protector

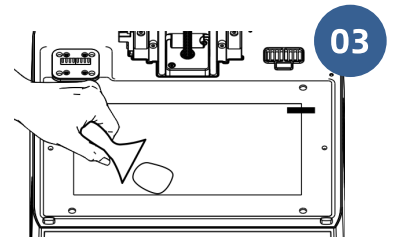

Squeeze out the
air bubbles

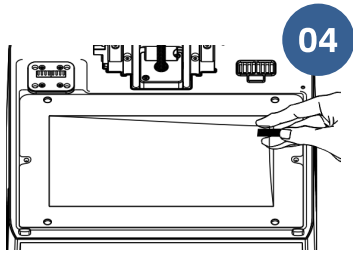

Peel off the film ②

3. Install the antenna.

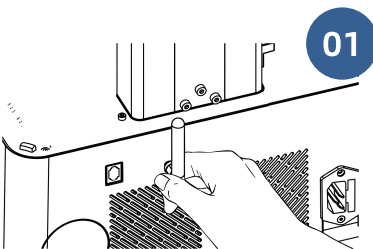

Preparations

4. Check the input mode of power voltage first. The one shown as "230" is suitable for 200V-240V; and the other one shown as "115" is suitable for 100V-120V. Then, connect to the power adapter and press the start button to turn on the printer. To power off, hold down the start button for 2s.

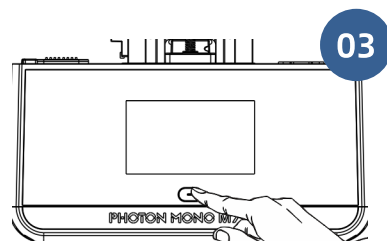
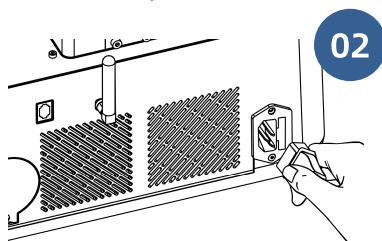
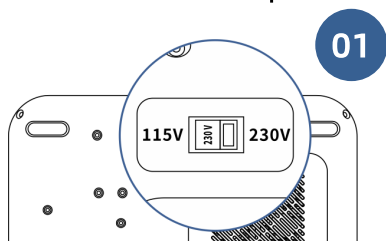

Voltage switch is located on the underside of printer

5. Set the system language and choose server location. Users in mainland Chinese please select "China", users in other countries and regions please select "Global". Then, complete the on-screen setup steps.

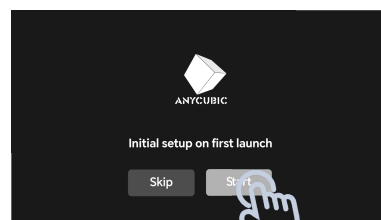
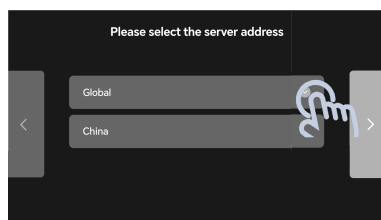

6. Install the print platform.

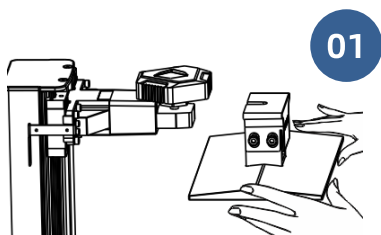

Push the platform onto the platform carrier

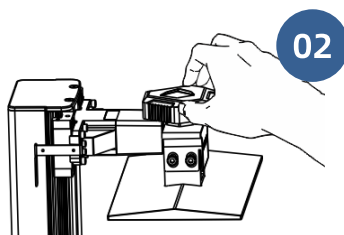

Tighten the knob

7. Install the resin vat.

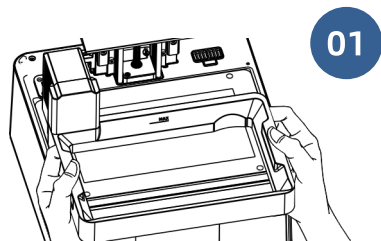

Put resin vat with its feet stuck in locating holes

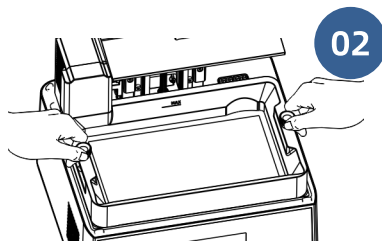

Tighten the two knobs

Preparations

8. Install the auto-fill unit (optional). Please remove the seal from the resin bottle first, as any residual seal on the bottle mouth may cause poor air tightness and affect the automatic feeding.

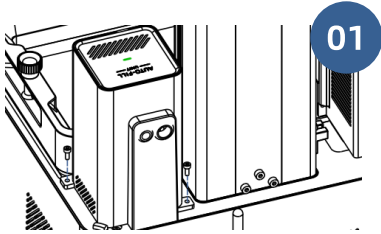

Secure the main module

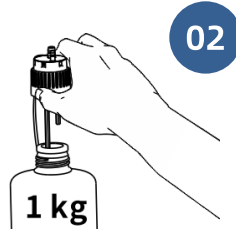

Use Anycubic 1kg resin bottle

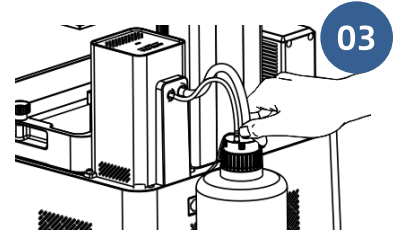

Connect the two pipes to the cap part



Insert the wire into the port on the back

Attention:

1. It is suggested to use the resin with a viscosity below 2000pcs, and place the resin bottle behind or on the right side of the printer.
2. Never vigorously shake or turn over the resin bottle when the cap part is installed. If the inside of the cap is stained by resin, please immediately clean it to avoid malfunction or damage to auto-fill unit.
3. The operating temperature for auto-fill unit is 10-40°C and the humidity range is 20-80%. For optimal performance, do not exceed these limits. If using Anycubic Bio Resin or Anycubic Rigid 100 Resin, the recommended ambient temperature is over 25°C. Otherwise, the functions of auto-fill unit may fail.

USB

1. Use Anycubic Photon Workshop software to process the 3D model file. The installer and instructions is saved in the USB drive.
2. When you set the parameters in Anycubic Photon Workshop, there are three groups of parameter which can be apply to the print with different needs.

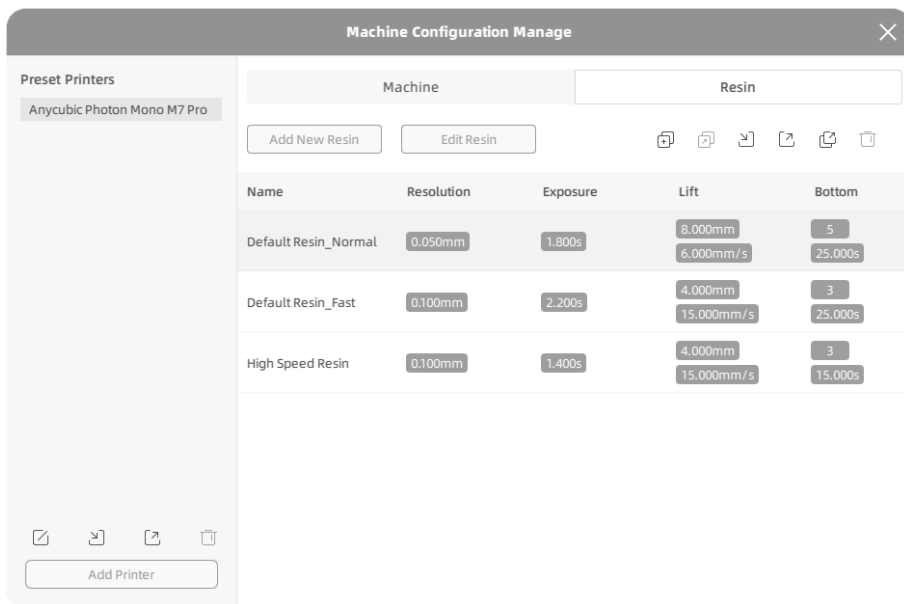

Choose the parameter group according to the personal requirement

① Default Resin_Normal

Apply to the Anycubic resin with normal printing speed. If the print object needs high accuracy, please modify the anti-alias level as 16 and the image blur as 3.

② Default Resin_Fast

Apply to the Anycubic resin with fast printing speed. The layer thickness is 0.1mm. Optimizing the Z-axis motion control increases the print speed.

③ High Speed Resin

Only apply to the Anycubic high speed resin with the fastest printing speed. The layer thickness is 0.1mm. Optimizing the Z-axis motion control increases the print speed.

Notice for parameter group②③:

1. The parameters apply to the model whose hollowed thickness is no more than 2mm.
2. The parameters must work with the ACF release film this printer provided to avoid print failure. The film can be used to print 45000 layers.

3. Save the sliced file to USB drive.

4. Then, insert the USB drive to the printer.

USB drive:

1. It is recommended that use the USB drive we provide. If you are using your own USB drive, please ensure that it is formatted to **FAT/FAT 32** and has a memory size of less than **64G**.
2. To ensure proper file reading, please put print files in the root directory of USB drive.

Cloud

Please connect the printer to Anycubic App first for remote uploading and monitoring.

1. Connect to the network.

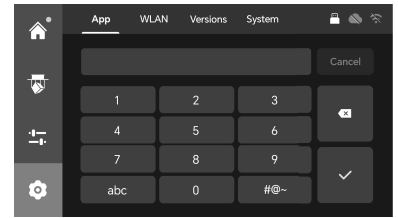
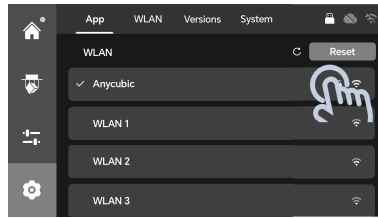
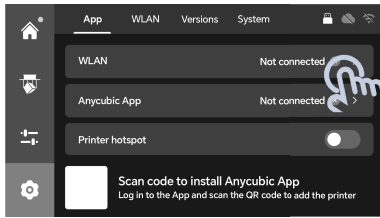

2. Please search "Anycubic" in App Store or Goolge Play, or scan the QR code on the printer, to download Anycubic App. Then, sign up and sign in.

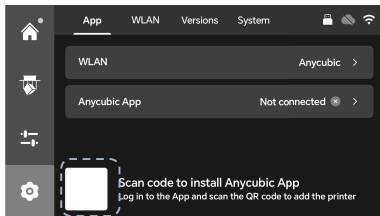

3. Add a printer in Anycubic App.

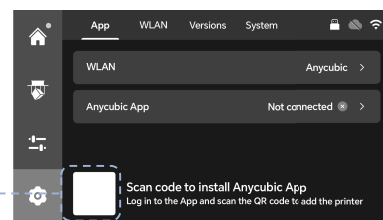
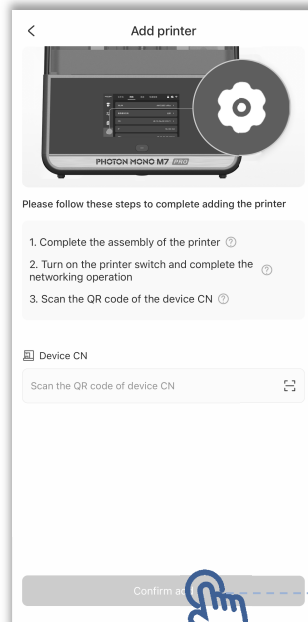
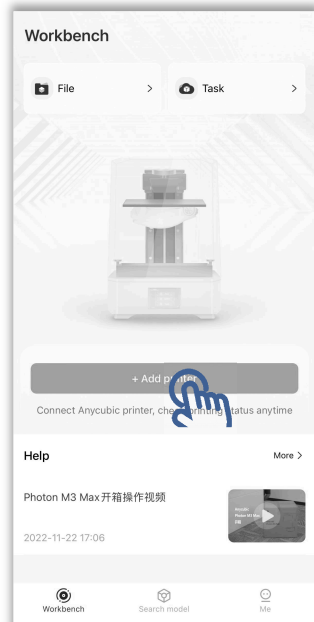

Scan the QR code to add printer

4. Search model or upload the model files.

- Search model

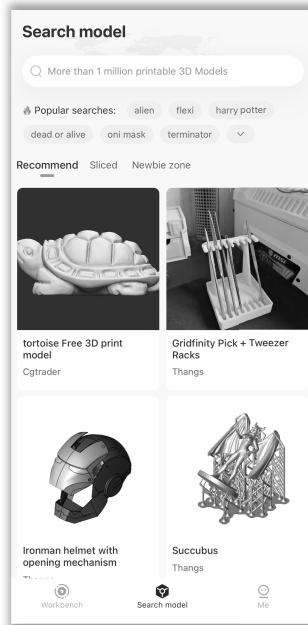
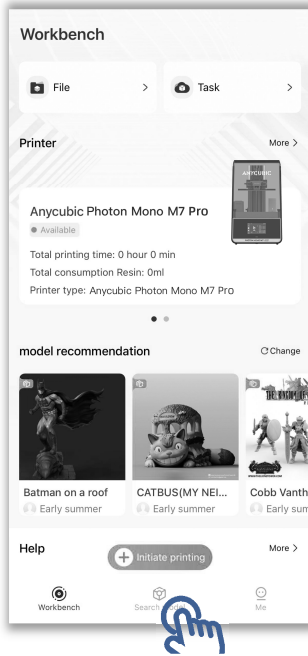

- Upload the model files

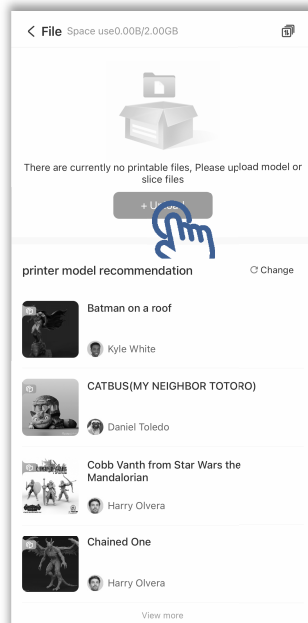
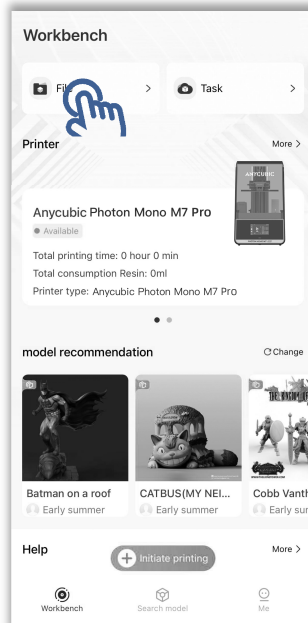

Resin Preparations

*The release film on the resin vat is consumable. Please pay attention to the status of release film on the touch screen and replace the film timely.

Please check the release film carefully before and after every printing. If the film is broken, replace it immediately to avoid further damage to the machine.

1. Make sure to wear a mask and gloves (to avoid direct skin contact with the resin), slowly pour resin into the vat, and make sure it is within the vat's maximum scale.

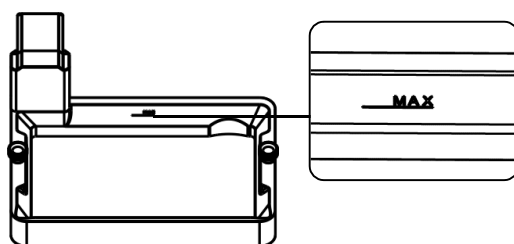

2. Enable the automatic feeding (optional). Please install the auto-fill unit before using.

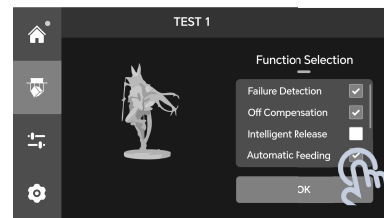
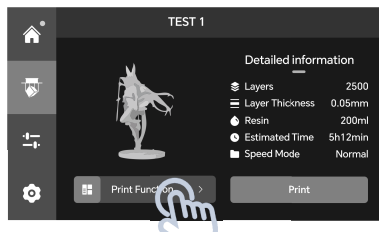
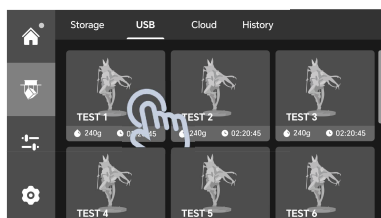

TIPS: When using resin with a viscosity over 500cps at room temperature (25°C), the resin bottle may experience slight deflation or inflation due to pressure changes. This is normal and does not affect loading and unloading.

3. When the ambient temperature is below 20 °C, it may cause the detachment of printed bottom or partial loss of printed objects. You can enhance the printing effect by enabling preprint heating.

Enable preprint heating. The printing starts when the resin temperature reaches 25 °C.

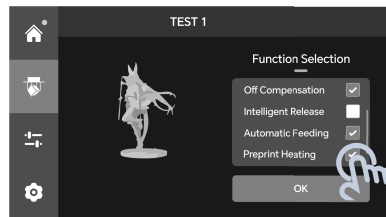
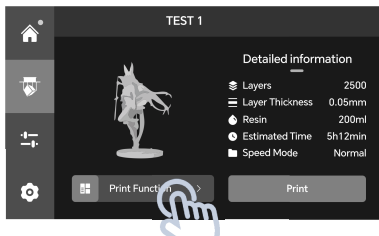

Attention :

1. Material circulation is enabled by default during heating process.
2. When the resin vat heats up for a long time, its surface temperature becomes high. Avoid touching the resin vat without protection after heating.

4. Put on the cover.

Print Test

Print File

Print USB drive file

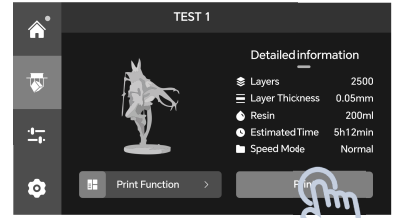
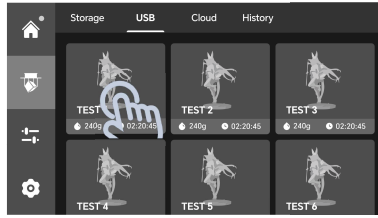
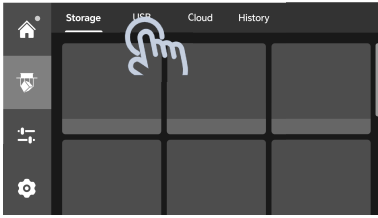

Remote print

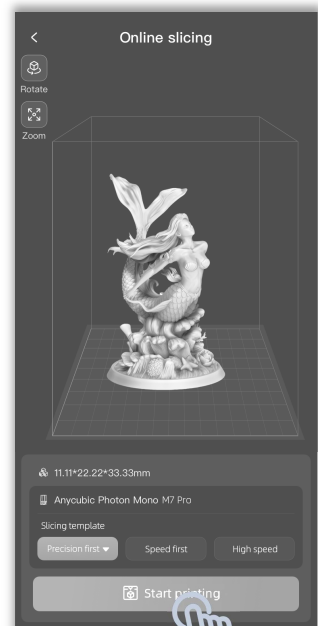
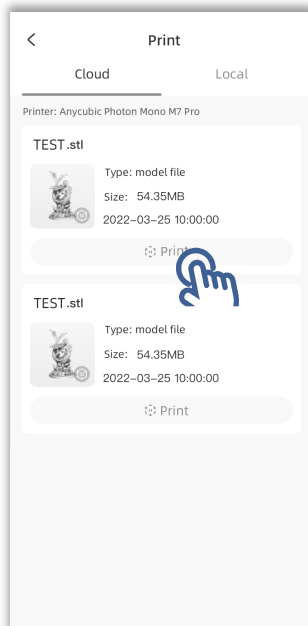
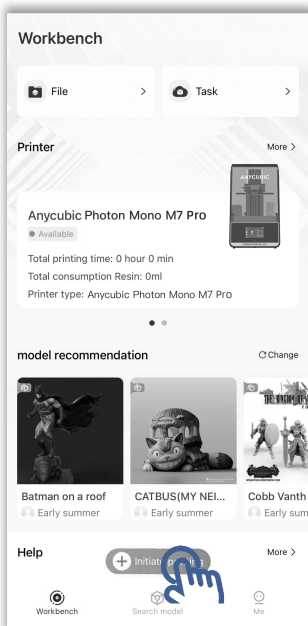

Before printing

1. Before printing, the printer checks the hardware condition, resin volume and residue before each print job. When there is an error, the printer will pop up the error QR code. Please scan the code and follow the guide.

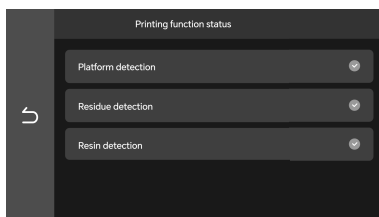

Platform Detection

Before printing, check whether the print platform is installed.

Residue Detection

Before printing, check if there are the solid residues* in the resin vat. If residues are detected, please clean the vat and check again.

*solid residue: height \geq 3mm, cross section \geq 9mm²

Resin Detection

Before printing, check whether the resin in the vat is sufficient to finish the print job. Usually, the required volume is a little more than the volume estimated by the slice software.

If the auto-feeding is enabled, the equipment will automatically replenish the resin when it detects the resin insufficiency.

2. If the resin in the bottle is insufficient, the printer will pop up warning. Please refill or replace the resin bottle timely.

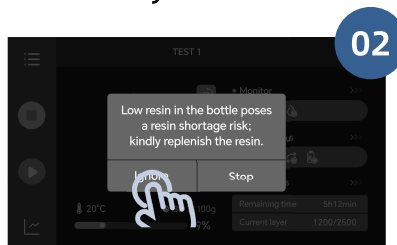
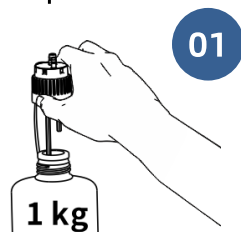

3. The feeding before printing can be skipped. If skipped at this time, it will not occur during printing.

4. You can choose to skip heating if necessary. Please be cautious, as low ambient temperature and insufficient heating time may lead to print failure.

In Printing

Failure detection: During printing, the printer automatically monitors the conditions which may cause print failure to avoid wasting resin or damaging to the printer. When the printer detects an abnormal condition, it will pause the print job automatically and pop up the error report. Please check the sliced file and the model according to the report. The failure detection is enabled by default.

Bottom non-stick detection

It checks whether the model sticks to the print platform.

When the printer detects that the model does not stick the platform, please check the bottom exposure time of the sliced file.

Off compensation: When the exposure area is large during printing, due to the surface tension and the resin characteristic, there may be problems such as delay of Z-axis or delay of resin reflowing, resulting print failure. It is suggested to enable off compensation to improve success rate.

The function is enabled by default.

Intelligent release: The function can improve the printing success rate by optimizing algorithm. Enabling intelligent release while printing with the default resin_normal parameter group can also increase printing speed.

The function is disabled by default.

Before printing, the functions can be enabled/disabled in the print function interface.

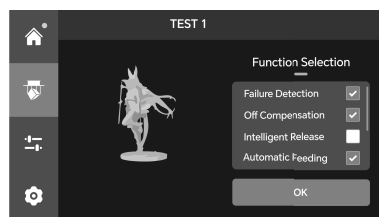
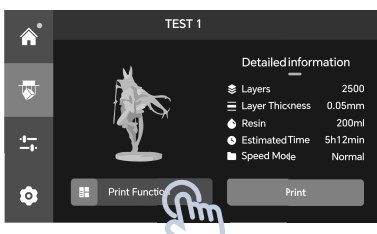

After Printing

1. After printing, remove the platform when resin stop dropping from the platform. Remove the model by metal scraper and then wash it with 95% alcohol or other detergent. After cleaning and drying, proceed with post-curing and any other necessary post processing of the model.
2. After printing, click “Unload” to recycle the resin. Use a plastic scraper to guide resin to the output of the auto-fill unit, facilitating the unloading process. However, if the printing fails, do not enable the unloading function to prevent the auto-fill unit from blocking or being damaged.

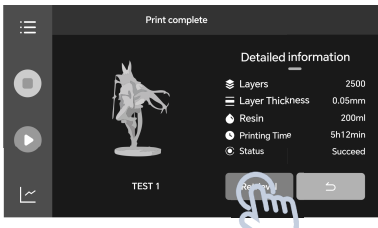

3. When the printing fails, resin may be cured partially in the vat. Please set to Cleaning and remove the residue. Otherwise, it may cause damage to the release film or LCD screen.

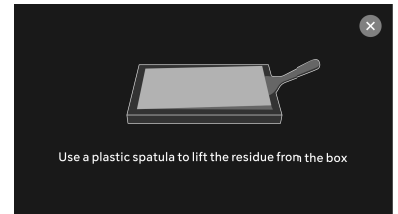
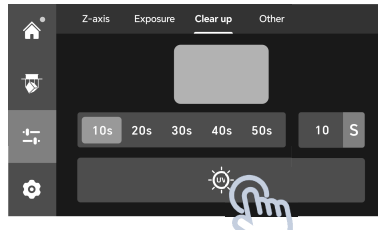

Remove resin sheet by plastic scraper

4. Please pour out the remaining resin through a front spout of the vat, and filter it by a funnel. Do not pour out the resin through the back side of the vat to avoid the damage to the resin vat.

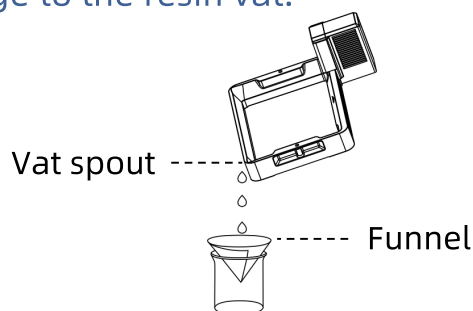

Resin Test

This function is used to find out the optimal parameters for different resins.

1. In Photon Workshop, import a custom test file, or enter resin exposure time and use preset file.

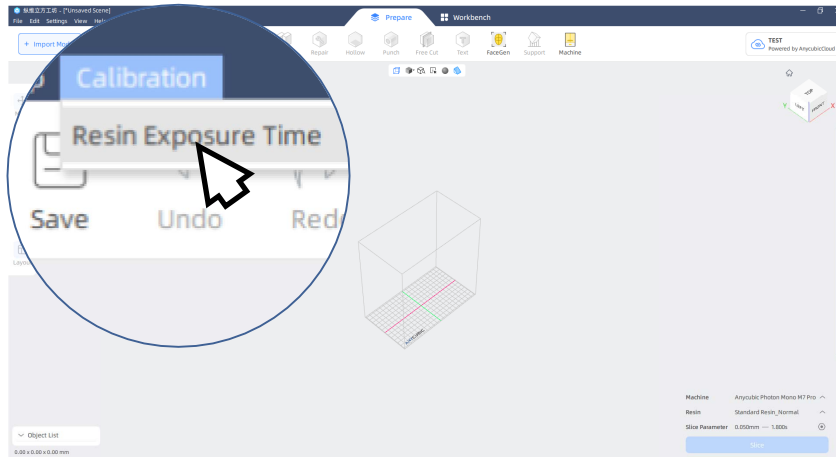

2. Finish the calibration test settings and then slice.

Print platform partitions: Divide the print platform equally into a certain number of areas.

Exposure time step: The exposure time of Area 1 is equal to the Normal Exposure Time, while the exposure times of other areas increase by the step value.

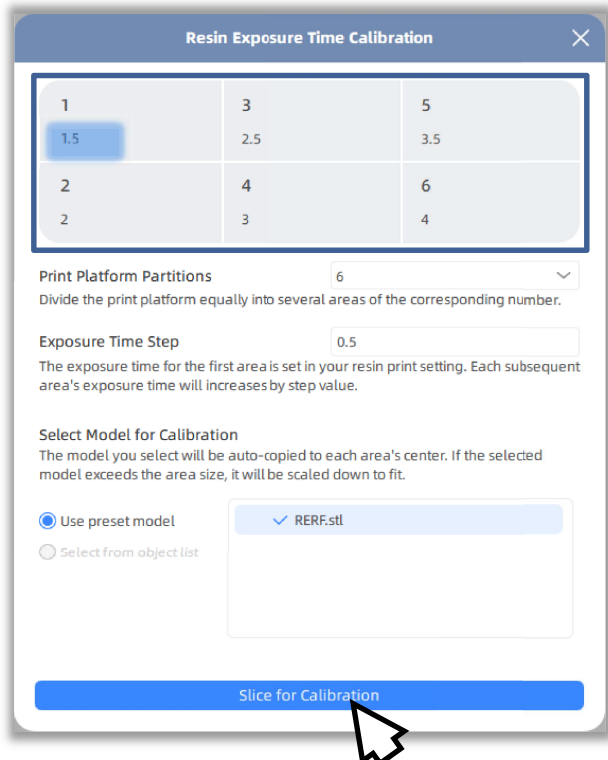
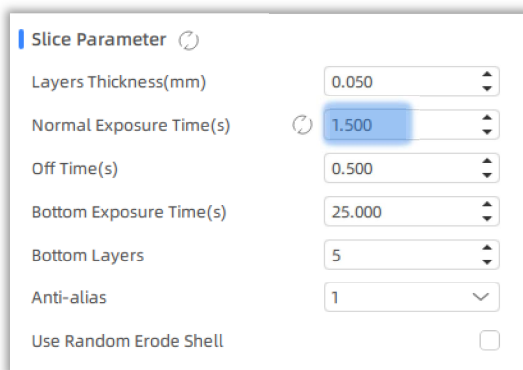

Resin Test

3. Check the exposure time step and print parameters in the slice file view. Then, export the resin test file.

Save the file to USB drive to start on the printer, or start remote printing.

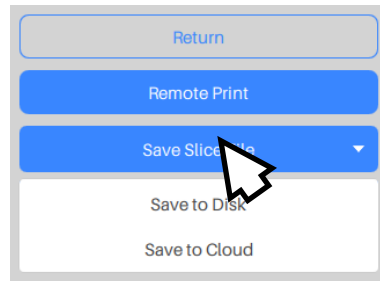

4. The exposure time can be modified in resin calibration interface on the printer. Then, print the file.



Attention: The exposure time of each area should be in strictly ascending order.

5. After printing, remove and clean the models.

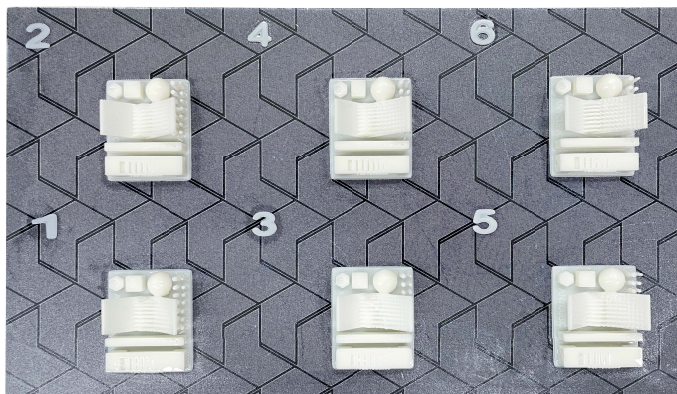

The numbers on the models indicate the order

6. Compare the print effect of models and choose the model's exposure time that meets your needs as the print parameter. Take a comparison of model A&B as an example.

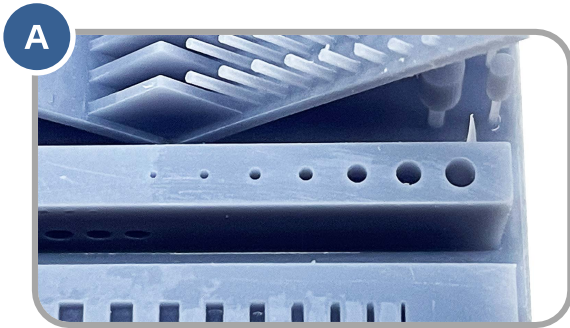

More holes



Less holes

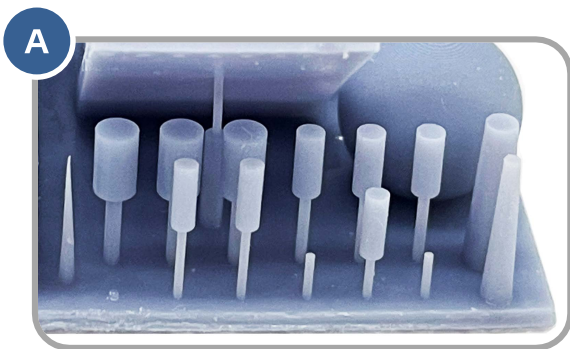

Less cylinder

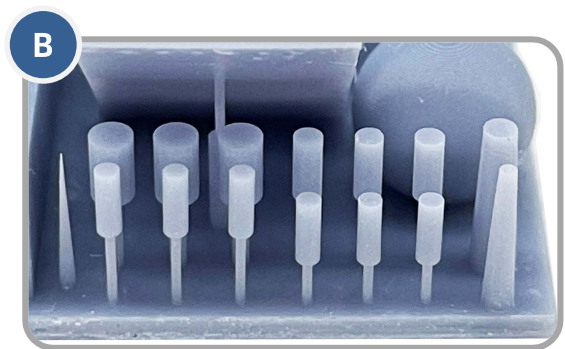

More cylinder

- Model A has more holes and fewer cylinder. If you print by the parameter of model A, more details of model can be printed with high risk of failure.
- Model B has fewer holes and more cylinder. If you print by the parameter of model B, model may be printed successfully yet with some details lost.

In addition, you can compare the bridges, needles or other parts to choose a proper model and find the parameter. If none of them can be chose, adjusting the "normal exposure time (s) " is suggested.

Tip: A preset file "R_E_R_F" is provided in the USB drive, which can be used for resin exposure testing.

Leveling

The printer has been designed requiring no leveling for the first use. However, please re-level the printer in the following scenarios:

- The print platform has been fallen to the ground.
- Changing new print platform or LCD screen.
- The printed object sticks to the resin vat instead of the print platform.



Scan the QR code for the leveling tutorial

Please follow the steps below to install and re-level.

1. Install the print platform.

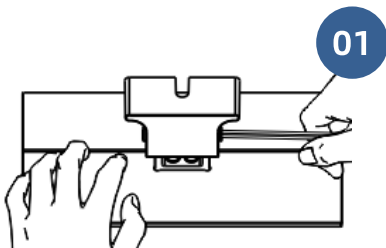

Loosen the four leveling screws

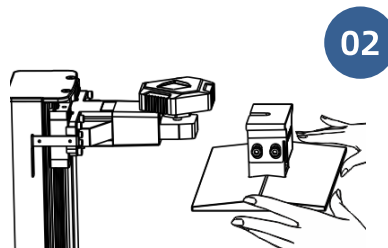

Push the platform onto the platform carrier

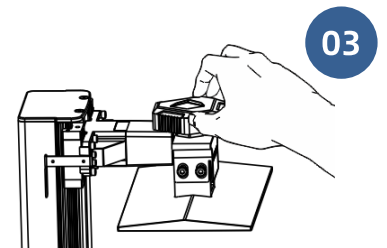

Tighten the knob

2. Leveling.



Place the leveling paper (included) on the LCD screen

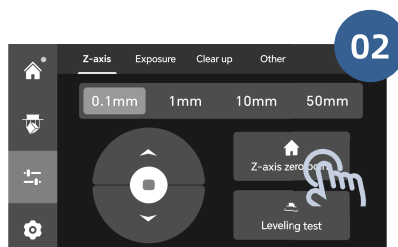

Click "Z-axis Home"

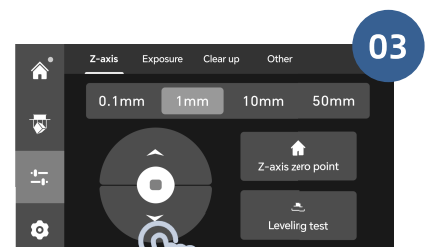

Lower Z axis by 1mm

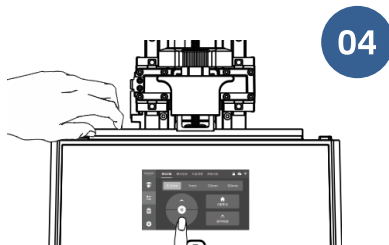

If the print platform shakes with light press, lower Z axis by **0.1mm** each time

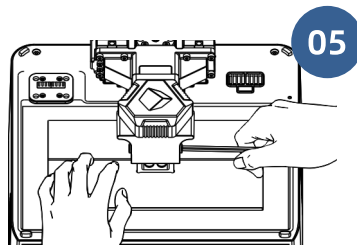

Lower until there is resistance when pulling out the leveling paper, hold the platform and tighten the four screws

3. Check whether the leveling is successful. If it does not match the result shown below, please loosen the four leveling screws and follow the step2 to re-level .

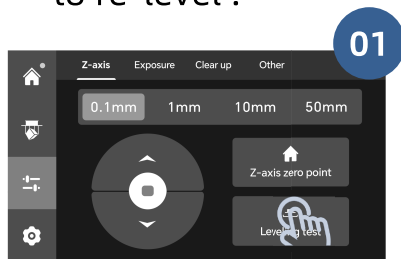

Click "Check Leveling"

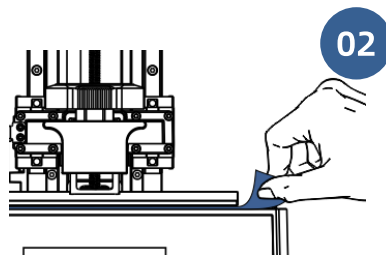

When you pull the leveling paper, there is a significant resistance or it cannot be pulled out

Resin Vat Maintenance

- **Remove the cured resin from release film:** Set Cleaning and then remove the cured resin sheet to protect the film. Do not use sharp objects to scrape off the residues from the film.

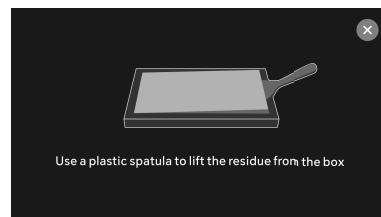
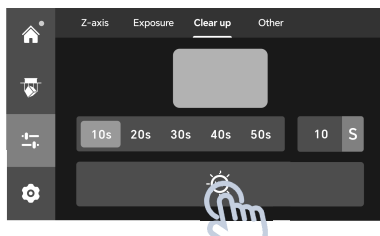
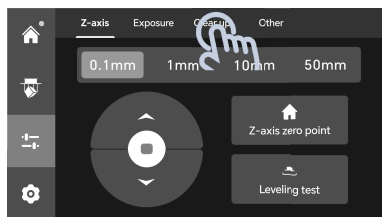

Remove resin sheet by plastic scraper

- **Remove the liquid resin from resin vat:** If there is only liquid resin in the vat, pour out the resin and then follow the steps of circulation cleaning to clean the vat.

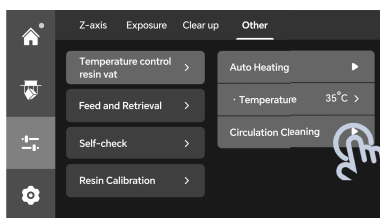
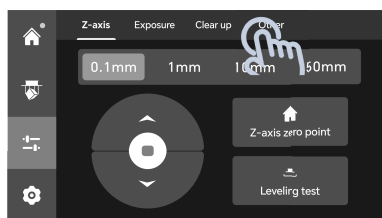

- **Release film replacement:** The statistics of print layers are shown in Home menu. Please check them and replace release film timely to avoid print failure or even the damage to printer.

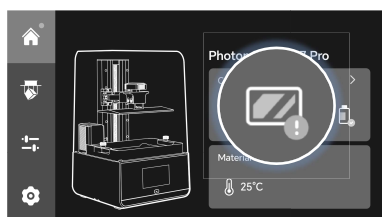

Need to replace release film

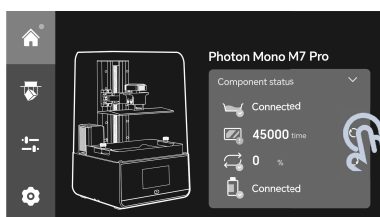

Click reset button after replacement

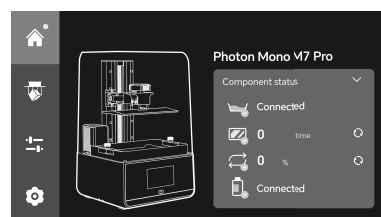

- If you do not use the resin for over 48H, store it in an airtight container away from light.
- If resin is stained on the resin vat, wipe it off timely. Never immerse the Temperature control resin vat in water, alcohol or other cleaning solvent to avoid the damage.
- It is suggested to use non-flexible resin with a viscosity below 1000 cps.

Replace Peristaltic Pump Pipe

Please replace the peristaltic pump pipe when the circulation time reaches 100%, as shown on the Home menu.

1. Put on gloves.
2. Remove the used peristaltic pump pipe.

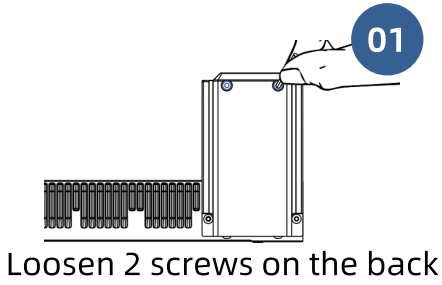

Loosen 2 screws on the back

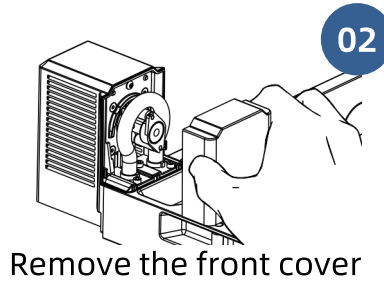

Remove the front cover

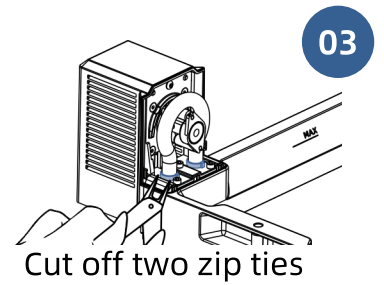

Cut off two zip ties

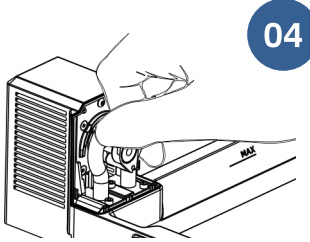

Remove the pump pipe

3. Install a new peristaltic pump pipe.

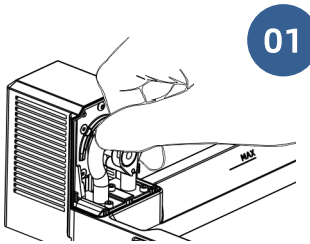

Insert a new pump pipe

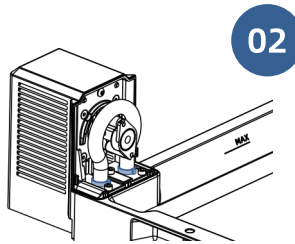

Secure the bottom of pipe with 2 zip ties

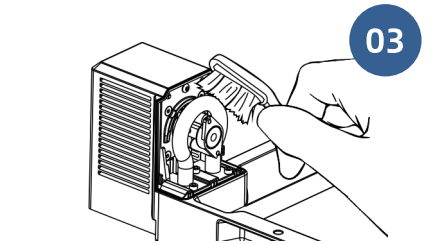

Grease the pipe and shaft

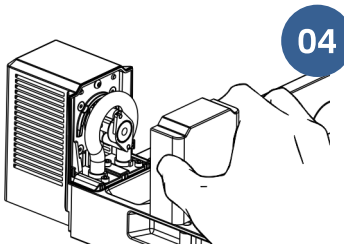

Put on the front cover

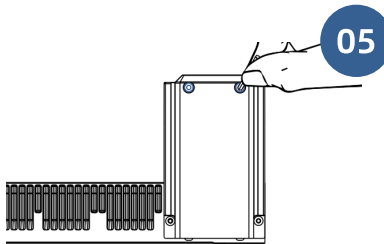

Tighten 2 screws on the back

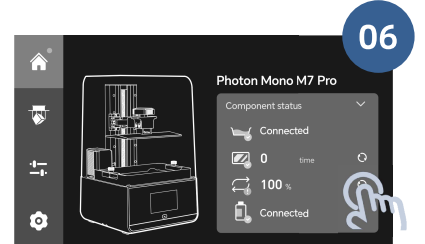

Reset the circulation time

Please fully insert the new pump pipe to the bottom to ensure proper installation.

Firmware Upgrade

- **USB upgrade:** Visit the official website to download the firmware and save it onto a USB drive that doesn't have any other version of firmware. Then, insert the USB drive to printer to upgrade.
- **OTA upgrade:** If the network is connected, directly upgrade by OTA.

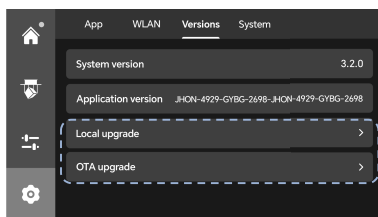
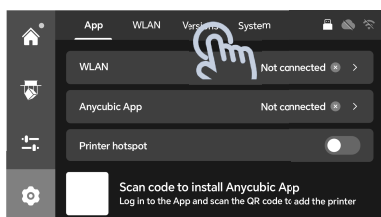

Z-axis Maintenance

If Z axis makes a noisy sound, please apply lubricant to Z lead screw.

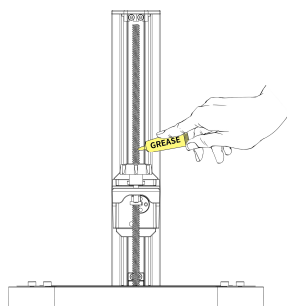

Cleaning

- **Clean the print platform:** Clean platform with alcohol and paper towel.
- **Protect LCD screen:** If there is resin being cured on the screen protector, please replace the protector immediately.
- **Clean the body of printer:** Clean the body of the printer with alcohol.

Complete the initial trouble shooting steps by referring to the following proposed solutions, or contact our technical support for additional assistance.

Print

1. Model do not stick to platform

- Bottom exposure time is insufficient. Please increase the exposure time.
- Contact area between the model and platform is small. Please add a raft.

2. Layer separation or splitting

- The machine is not stable during printing.
- The release film is not tight enough or needs a replacement.
- The printing platform or resin vat is not tightened.
- The lift speed is too fast.
- The model is hollowed without punching.

3. Layer shift

- Add supports.
- Reduce the lift speed.

4. Floccules left in resin vat or attached to models

- The exposure time is too long. Reduce the normal exposure time and bottom exposure time.

Cloud connection

1. WLAN connection is failed

- WLAN name or password is wrong. Please reset the network and reconnect.
- The WLAN network is unavailable. Join an available network. Then, reset the network and reconnect.

2. Fail to add printer in App

- Check "Server Location" . Users in mainland Chinese please select "China", users in other countries and regions please select "Global".

Complete the initial trouble shooting steps by referring to the following proposed solutions, or contact our technical support for additional assistance.

Auto feeding & Unloading

1. The printer prompts that resin in the vat is not enough before printing.

- The auto-fill unit has a poor connection to the printer. Please reinstall the auto-fill unit and then click “OK” .
- The auto-fill unit has been malfunctioned because resin entered in the air pipe.

2. The resin in the bottle is sufficient, but the printer prompts no resin in the bottle.

- The cap part has a poor connection to the printer. Please reinsert the cap part wire.

3. The resin liquid level reaches the needles of the auto-fill unit. However, when you click “unload” , the printer immediately prompts that unloading completes.

- The thumb screws securing the resin vat are not tightened. Please stop unloading and tighten the thumb screws.



Disposal of Electronic Components

This symbol indicates that the device must not be disposed of with household waste. When this product reaches the end of its life, please dispose of it in accordance with local environmental regulations. Take it to a collection point for the recycling of waste electrical and electronic equipment. Proper disposal helps prevent environmental and health hazards caused by inappropriate handling of electronic waste. Recycling also supports the conservation of natural resources. Do not dispose of this product with unsorted municipal waste.

Thank you for purchasing Anycubic products! Under normal usage and service, the products have a warranty period of up to one year. Please visit Anycubic support center(support.anycubic.com/en) to report any issues with Anycubic products. Our professional after-sale service team would respond within 24 hours and solve the issues.