

# N60B PDA HANDHELD TERMINAL

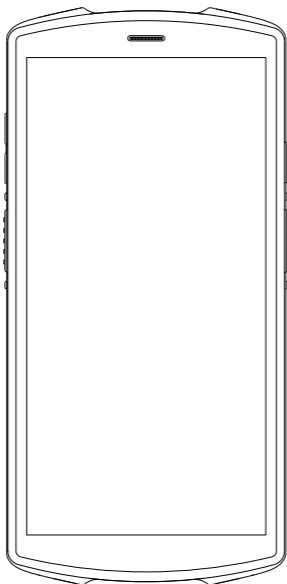

Quick Guide

# OVERVIEW

---

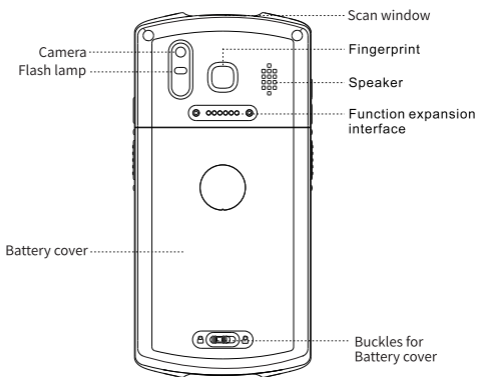
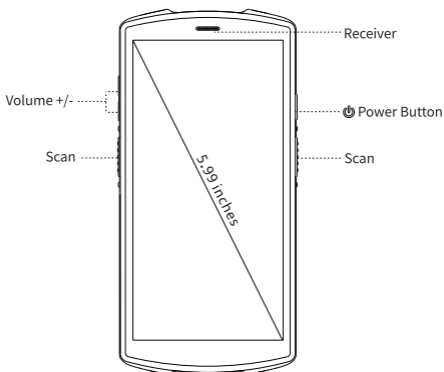

## Shortcut key

Screen capture : "power" + "Volume -"

# OPEN THE BATTERY COVER

1. Flip the battery compartment switch to the right.

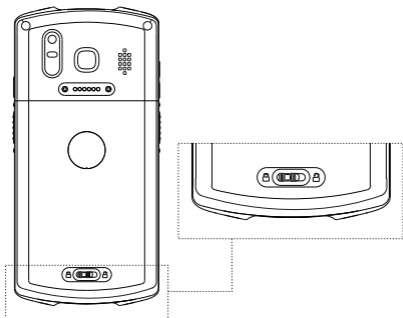

2. Then push the battery compartment cover out in the direction of the arrow

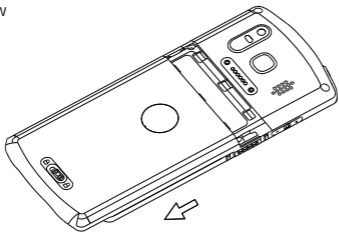

3. Then open the battery compartment cover to remove the battery

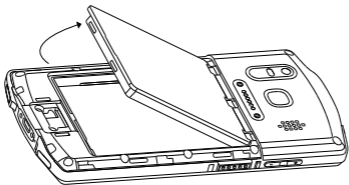

\* Please peel off the yellow insulation sticker pasted on the positive and negative of battery before turning on the device

# EQUIPMENT CHARGING

---

## DEVICE CHARGING:

1. Use the USB cable that comes with the device and plug it into the Type-C connector to charge.
2. Use cradle to charge. (Cradle purchased separately)

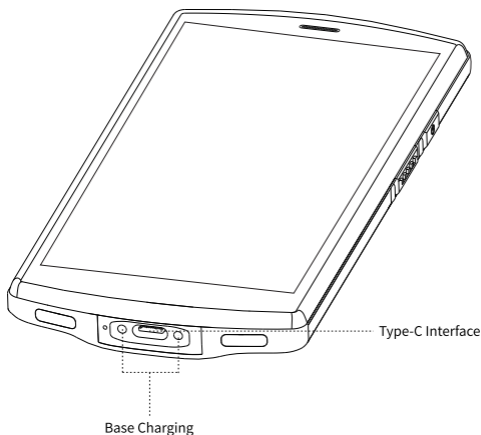

- \* To prevent the battery from being over-consumed, please charge the device when the battery power is less than 20%. If the battery has been in a over - consumption status, please charge the device for 20-30 minutes. Then it will display a normal charging status.

# SCAN (OPTIONAL)

If your PDA is equipped with the SCAN function, please operate it as below:

1. Please open the Scanner App. ( As Pic 1 )
2. In the SCAN interface, press scan button to scan the barcode.



( As Pic 1 )

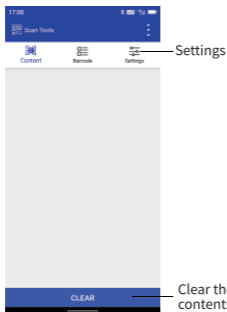

( As Pic 2 )

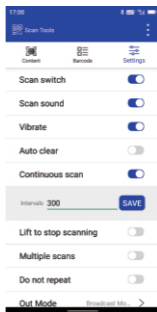

( As Pic 3 )

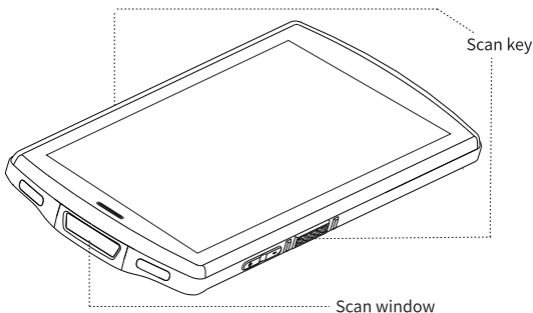

## NFC(OPTIONAL)

---

If your PDA is equipped with the NFC function, please operate it as below:

1. Please open the NFC app. ( As Pic 1 )
2. In the NFC interface, please read the card in NFC reading area.



( As Pic 1 )

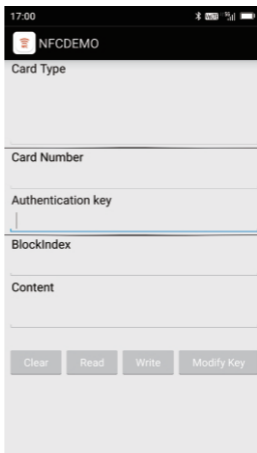

( As Pic 2 )

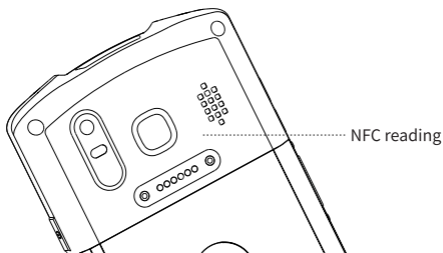

Note: NFC is only available for models with this function option.

# FINGERPRINT(OPTIONAL)

If your PDA is equipped with the FINGERPRINT IDENTIFICATION function, please operate it as below:

1. Please go to setting in the program ( As Pic 1);
2. Click fingerprint→ fingerprint management → unlock with fingerprint;
3. In the fingerprint test interface ( As Pic 2), Collect and identify fingerprints;



( As Pic 1)

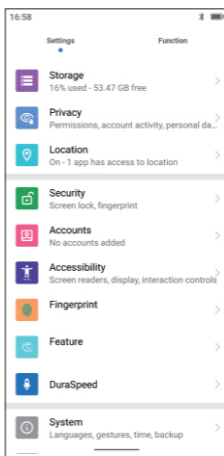

( As Pic 2)

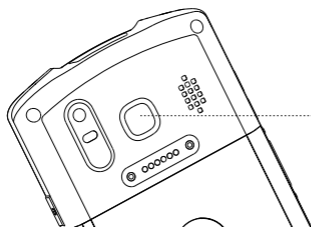

Fingerprint identification area

Note: FINGERPRINT IDENTIFICATION is an optional function. Please make sure the PDA is equipped with fingerprint identification function before using it.

## OTA(UPDATE ONLINE)

---

OUR PDA SUPPORT OTA (UPDATE ONLINE) FUNCTION, YOU CAN UPDATE THE LATEST FIRMWARE BY OTA, OPERATE IT AS BELOW:

- 1.Please enter into “Settings” – About phone.
- 2.Press “System update” and enter into the updating firmware interface.
- 3.Press “Update checking” to update the OS.

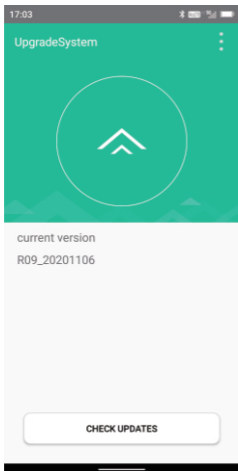

( As Pic 1)

# FAQ:

---

## 1.How to restore factory settings?

Select “Setting” → “System” → “Reset option” → “Factory date reset”

## 2.Why can not open the PDA?

(1) if the new device doesn't turn on, please make sure that the insulation sticker has been removed.

(2) Press the power button for 4s until the device screen starts to display and then release the power button.

(3) Please check if the battery has power, put the battery into PDA and charge it, if the screen shows charging icon, charge the PDA for some time and restart it.

## 3.PDA can not connect to the PC?

If you connect the PDA with your PC ,and no prompt messages appear, please change another cable to test, if not work, please change another pc.

## 4.When using scanner , there is no data but scan-light on,Why?

(1) Go to scan setting , and check “keyboard output” .

(2) If checked ,then please reset the scan demo for twice , and operate “OFF” -- “ON” .

## 5.The device cannot scan the code.

(1) Check if each scan button can be used normally.

(2) Check if the scan engine supports the barcode.

(3) Check if the scanning lens and barcode is clear and unobstructed.

(4) Check the scan setting and reset .

## 6.The device can not charge.

(1) Check if the device adapter and charging port are good.

(2) If the device hasn't been used for a long time, please keep it charged for 30 minutes. Then check whether the device lights on or not.

(3) Replace the battery of the device that can be turned on normally, check the problem on battery or device.

## 7.How to use the battery correctly?

The battery is Li-ion battery, if no power , please immediately charge it, Don't keep the battery with full power or no power for long time, The best way is to keep 50% power of the battery to store it. And if you don't use the PDA for long time, please pull out the battery from PDA and store it.

COMMITTED TO THE WORLD OF THINGS , CREATING A SMART LIFE